

OFFICE OF THE PRINCIPAL, RAJDHANI COLLEGE, BHUBANESWAR

NO. 616 // DT. 17.2.23

TENDER CALL NOTICE

Sealed quotations are invited from registered firms / agencies having up-to-date GST clearance for **Development of Laboratory Infrastructure and supply of Laboratory Equipments and Chemicals** in separate envelops. Quotations with name of the department "DEPARTMENT OF _____" super scribed on the cover should reach the office of the undersigned on or before 27.02.2023 by 02.00 P.M positively.

The sealed quotations will be opened in the presence of bidders / representatives on the same date i.e 27.02.2023 at 03.00 P.M

The details of the specification are available on the College Website www.rajdhanicollege.org.in.

The authority reserves the right to cancel / reject the quotations without assigning any reason thereof.

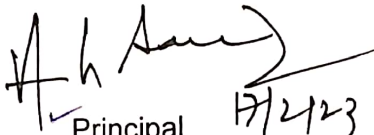
Principal 17/2/23
Rajdhani College, Bhubaneswar

Memo No. 617 Dt. 17.2.23

Copy to College Notice Board / OIC Website / Accounts Bursar / H.C/ Cashier for information and necessary action.

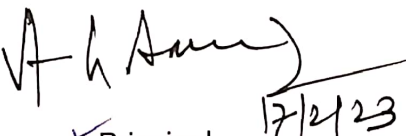
Principal 17/2/23
Rajdhani College, Bhubaneswar

CHEMISTRY

LIST OF EQUIPMENTS AND APPARATUS

Chemistry Department

Sl. No.	Name	Quantity	Made/specification
1	PH meter	1	<ul style="list-style-type: none"> • Large, easy-to-read display • Ready indicator let you know when readings are stable • Up to 5-point calibration with auto-buffer recognition • Non-volatile memory holds up to 100 data points Integral electrode holder pH Range: -2.00 to 16.00 pH Resolution: 0.01 pH Accuracy: ± 0.01 pH Cal. Points: Up to 5 Buffer Sets: USA (1.68, 4.01, 7.00, 10.01, 12.45), NIST (1.68, 4.01, 6.86, 9.18, 12.45) ORP Range: ± 2000 mV Rel. mV Range: ± 2000 mV Resolution: 0.1 mV (± 199.9 mV) / 1 mV (beyond) Accuracy: ± 0.2 mV (± 199.9 mV) / ± 2 mV (beyond) Temperature Range (Meter): 0.0 to 100.0 °C / 32.0 to 212.0 °F Resolution: 0.1 °C / 0.1 °F Accuracy: ± 0.3 °C / ± 0.5 °F (0 to 70 °C) Compensation: ATC / MTC (0 to 100 °C) (pH only) Calibration: Offset in 0.1 °increments; offset range: ± 5.0 °C / ± 9.0 °F Power Requirements: 9 V DC adapter, 1.3 A (100/240 VAC, SMPS)
2	Ostwald's Viscometer	5	Borosil/ pore diameter=1 mm length = 90 mm size=23 mL (size G-H)
3	stalagmimeter	5	Borosil/ volume=5 mL
4	kipp's Apparatus	1	Borosil /volume=250mL
5	separating Funnel	2	Borosil 1. volume=250mL 2. pear shape 3. boro stopcock & I/C glass stopper (24/29)
6	Micro pipette	1	1. volume range(μ L)=1000-10000 2. increment (μ L)= 20 3. Accuracy ($\pm \mu$ L)= 60
7	Projector	1	Education Projector MW560, DLP, 4000 Lumens High Brightness, 22000:1 High Contrast Ratio, Dual HDMI, Upto 15000 hrs Extra-Long Lamp Life, 10W Speaker, 3D Capable

List of Chemicals

Chemistry Department

Sl.No	Chemicals	Quantity
1	Acetone	2×500 ml
2	carbon tetra chloride	2×500 ml
3	poly ethylene glycol	500 ml
4	poly vinyl alcohol	500 gm
5	Magnesium sulphate	500 gm
6	Magnesium chloride	500 gm
7	Nessler's reagent	2×100 ml
8	Phenolphthalein indicator	5×125 ml
9	Cyclohexanol	500 ml
10	Sodium dichromate	500 gm
11	Methanol	2×2.5 lit
12	Diethyl ether	500 ml
13	Sodium metabisulphite	500gm
14	p-toluidene	500 gm
15	Wij's solution	500 ml
16	Potassium iodide	250gm
17	Phenol	500gm
18	Silver sulphate	25gm
19	Mercuric sulphate	250gm
20	Nickel chloride	500gm
21	Ammonium Nickel sulphate	500gm
22	Aluminum sulphate	500gm
23	Lead sulphate	500gm
24	Hydrochloric acid	5 lit
25	poly acryl amide	250gm
26	poly styrene	500gm

LIST OF INFRASTRUCTURE

Chemistry Department

Sl. No.	Product Name	Technical Specification	Preferred Brand
1.	Steel Almira	<p>Size & Technical Specification: Size of 1980(h) x 915(W) x 485(d) mm, storage shelves 4 no. adjustable make five compartment. High quality cold rolled close annealed (CRCA) sheet. Anticorrosion treated components, treated with seven steps anti corrosion process as per IS: 3312: 84 standard. Thickness of sheet is 20 gauge front. Three way bolting device and six lever lock (Dual Lock) with high quality hinges an overlapping doors. Oven baked powder coated. Color -grey.</p> 	Godrej/Methodex/Featurelite & Equipment

ZOOLOGY

EQUIPMENT LIST – ZOOLOGY DEPARTMENT

Sl. No.	Item	Specification
1	Projector	Education Projector MW560, DLP, 4000 Lumens High Brightness, 22000:1 High Contrast Ratio, Dual HDMI, Upto 15000 hrs Extra-Long Lamp Life, 10W Speaker, 3D Capable Brand – BENQ / SONY / OTHER TOP BRANDS
2	MINI Vertical gel electrophoresis casting, running and transfer module with power pack	Tank, lid with power cables, electrode assembly Mini cell buffer dam, 2 casting stands with 4 casting frames 10 glass plates for 1.0 mm thick gels (5 complete sets; 5 glass plates per box), Five 10-well combs with gel releasers , The Mini Trans-Blot Module includes, 2 gel holder cassettes, Foam pads, Electrode assembly, Cooling unit, The PowerPac HC Power Supply Brand – BIORAD / BIOCOPARE / THERMO FISHER SCIENTIFIC / OTHER TOP BRANDS
3	pH Meter	<ul style="list-style-type: none"> • Large, easy-to-read display • Ready indicator let you know when readings are stable • Up to 5-point calibration with auto-buffer recognition • Non-volatile memory holds up to 100 data points <p style="text-align: center;">pH</p> <p>Range: -2.00 to 16.00 pH Resolution: 0.01 pH Accuracy: ± 0.01 pH Cal. Points: Up to 5 Buffer Sets: USA (1.68, 4.01, 7.00, 10.01, 12.45), NIST (1.68, 4.01, 6.86, 9.18, 12.45) ORP</p> <p>Range: ± 2000 mV Rel. mV Range: ± 2000 mV Resolution: 0.1 mV (± 199.9 mV) / 1 mV (beyond) Accuracy: ± 0.2 mV (± 199.9 mV) / ± 2 mV (beyond)</p> <p style="text-align: center;">Temperature</p> <p>Range (Meter): 0.0 to 100.0 °C / 32.0 to 212.0 °F Resolution: 0.1 °C / 0.1 °F Accuracy: ± 0.3 °C / ± 0.5 °F (0 to 70 °C) Compensation: ATC / MTC (0 to 100 °C) (pH only) Calibration: Offset in 0.1 °increments; offset range: ± 5.0 °C / ± 9.0 °F Power Requirements: 9 V DC adapter, 1.3 A (100/240 VAC, SMPS)</p> <p style="text-align: center;">Brand –THERMO FISHER SCIENTIFIC / METTLER TOLEDO / OTHER TOP BRANDS</p>
4	Lactodensimeter	Graduated Digital Lactodensimeter for finding the density of the milk. (Branded Good Quality)

CHEMICALS LIST: DEPARTMENT OF ZOOLOGY,
RAJDHANI COLLEGE-2023

Sl. No.	Product name	packing	Quantity
1	Amino Acids Kit (24 Amino Acids of Reference Standard Grade) (Each kit contains 24 Amino Acids , 1gm of each. Assay min 99% and TLC test shows single spot) DL-Alanine, DL-2-Aminobutyric acid, L-Arginine monohydrochloride, DL-Aspartic acid, L-Cysteine monohydrochloride, L-Cystine, 3-3, 4-Dihydroxyphenyl DL-alanine (DL-DOPA), L-Glutamic acid, Glycine, L-Histidine monohydrochloride, L-Hydroxyproline, DL-Isoleucine, DL-Norleucine, L-Leucine, L-Lysine monohydrochloride, DL-Methionine, L-Ornithine monohydrochloride, DL-Phenylalanine, L-Proline, DL-Serine, DL-Threonine, L-Tryptophan, L-Tyrosine, DL-Valine)	1 kit	1
2	L-Tyrosine	100 gm	1
3	L-Alanine	25g	1
4	Tris	500 gm	1
5	Boric Acid extrapure, 99.5%	500gm	1
6	Phenol Equilibrated with 0.1M Citrate Buffer pH 4.5 for molecular biology w/ Stabilizer	500 ml	1
7	Magnesium Chloride Anhydrous extrapure, 98%	100gm	1
8	Chloroform extrapure 99%	500ml	1
9	Potassium metabisulphite pure 95%	500 gm	1
10	EDTA Disodium Salt Dihydrate extrapure AR, 99.5%	500 gm	1
11	Ethanol molecular biology grade	500 ml	1
12	Isoamyl alcohol extrapure AR, 99%	500 ml	1
13	Potassium acetate pure 99%	500 gm	1
14	Glycerol for molecular biology, 99.5%	100 ml	1
15	Potassium hydroxide pellet extrapure, 95%	500 gm	
16	Distilled and deionised water	5 lit	4
17	Sodium acetate Anhydrous extrat pure 98%	500 gm	1
18	Sodium hydroxide pellets purified, 97%	500 gm	1
19	LB- Media (Molecular biology and bacteria culture grade)	500 gm	1
20	LB- Agar (Molecular biology and bacteria culture grade)	100 gm	1
21	Eco R1 (highly purified and accompanied with reaction buffer)	4000 units	1
22	Bromophenol blue extrapure AR	25 gm	1
23	Acetic acid glacial extrapure AR, 99.9%	500 ml	1
24	Acrylamide extrapure, 99.5%	500 gm	1
25	N,N'-Methylene Bisacrylamide pure 98%	100 gm	1
26	Agarose low EEO for molecular biology	500 gm	1
27	PreStained Blue Protein Marker: 14 - 66kDa	0.5 ml	1
28	TEMED extrapure AR, 99%	100 ml	1
29	X-Gal for molecular biology, 98%	100gm	
30	Ampicillin Sodium Salt (AMP-Na) for biochemistry & microbiology	5 gm	1
31	Ammonium Persulphate pure, 98%	500 gm	1
32	Ethidium Bromide extrapure, 98%	1 gm	1
33	Paraffin Wax White Soft pure (suitable for histology Melting point 38 to 56 degree C)	500 gm	1
34	Schiff's Regent	500 ml	1

35	Methyl Green (Zinc Chloride Double Salt)	5g	1
36	Pyronin G (Pyronin Y)	1 gm	1
37	p-nitroaniline (p-NA) extrapure, 98%	250 gm	1
38	L-BAPNA extrapure 98% for biochemistry	250 gm	1
39	IPTG 99% for routine biochemistry	1 gm	2
40	2-Mercaptoethanol for molecular biology, 99% (Dnase, Rnase and protease free)	250 ml	1
41	Ethanol	500 ml	5

PLASTIC WARE, DEPARTMENT OF ZOOLOGY, RAJDHANI COLLEGE-2023			
1	Single sterile petri dish , Diameter-90mm, size 14 mm and material-polystyrene, Triple Vent Radiation Sterile : Vented dishes have elevated lid which allows for good gas exchange and encourage evaporation. The design of the dish should maintains sterility.	450 pcs	1
2	Universal Combi Rack , must be designed to support a variety of tube sizes. The rack may be rotated to any of the position. 30 mm: 50 ml tubes for 8 places, 20 mm: for 20 places, 17 mm: 15 ml tubes for 24 places, 12 mm: RIA tubes for 40 places	4 pcs/packing	1
3	Measuring cylinder 15 ml	12 per pack	1
4	Measuring cylinder 25 ml	12 per pack	1
5	Measuring cylinder 100 ml	6 per pack	1
6	Measuring cylinder 500 ml	4 per pack	1

GLASS WARE, DEPARTMENT OF ZOOLOGY, RAJDHANI COLLEGE-2023			
1	Microscopic slides Plain, Ground Edges (Dimentions:76 x 26 x 1) Ultra transparent	50 per pack	5
2	Slide cover glass (Square 22 x 22) Ultra transparent	100/ pack	2

INFRASTRUCTURE DEPARTMENT OF ZOOLOGY-2023

Sl. No.	ITEMS	SPECIFICATIONS	Price /Unit	Quantity	
1.	Laboratory Wall Cabinets Over Head Solid Shutter (Steel)	Material -MS-Steel, powder coated (20 gauze),			Goodrej/ Methodex/ Featherlite and Equivalent
		Compartment- 2			
		Shelves- 1			
		Shelves type- Adjustable			
		Double shutter - Solid			
		Dimension-600W-320D-674H			

N.B – Tenderers are requested to visit the Zoology Lab and submit the estimate according to the specification in connection with Laboratory Wall Cabinets.



PHYSICS

Equipment List
Physics Department

Sl.No.	Equipment	Quantity
1.	e/m measurement by magnetic valve method	
2.	e/m measurement by Thomson Method	
3.	Babinet's Compensator	
4.	Fabry-Perot Interferometer	
5.	Stefan's constant Measurement	
6.	Determination of Planck's constant by total Radiation method	
7.	Hysteresis loop tracer	
8.	i3 Desktop 12 th Gen, 8GB RAM, 512 SSD, 20" Monitor, Windows 11, Office 2021	
9.	UPS (Frontech/APC/Zebronics)	

Infrastructure List

Physics Department

Sl. No.	Product Name	Technical Specification	Preferred Brand
1.	Book Case	<p>Size of 1675 (h) x 8405 (w) x 310 (d) mm, shelves 4 no. Front open with transparent glass. High quality cold rolled close annealed (CRCA) sheet. Anticorrosion treated components, treated with seven step anti corrosion process as per IS: 3312:84. Thickness of door frame should be 18-20 gauge having transparent 5mm front glass and rest body 20-22 gauge. Oven baked powder coated. Color -grey.</p> 	Godrej/Methodex/Featurelite & Equipment
2.	Steel Almirah	<p>Size & Technical Specification: Size of 1980(h) x 915(W) x 485(d) mm, storage shelves 4 no. adjustable make five compartment. High quality cold rolled close annealed (CRCA) sheet. Anticorrosion treated components, treated with seven steps anti corrosion process as per IS: 3312: 84 standard. Thickness of sheet is 20 gauge front. Three way bolting device and six lever lock (Dual Lock) with high quality hinges an overlapping doors. Oven baked powder coated. Color -grey.</p> 	Godrej/Methodex/Featurelite & Equipment

MATHEMATICS

LIST OF EQUIPMENTS

MATHEMATICS DEPARTMENT

Sl.No.	Type	Specification	No.
01.	i5 (Desktop)	12 th Gen, 8GB RAM, 512 SSD, 20" Monitor, Windows 11, Office 2021	HP/Dell/Lenovo/Acer
02	i3 (Desktop)	12 th Gen, 8GB RAM, 512 SSD, 20" Monitor, Windows 11, Office 2021	HP/Dell/Lenovo/Acer
03	UPS		Frontech/APC/ Zebronics

LIST OF INFRASTRUCTURE
MATHEMATICS DEPARTMENT

INFRASTRUCTURE DEPARTMENT OF MATHEMATICS -2023			
Sl.No.	Type	Specification	No.
01.	Computer Table		Wooden Computer Table, Size/Dimension: 4 X 2 X 2.5 Feet Good Quality Brands
02.	Computer Chair		Dimensions W x H x D (cm) 75.6 x 88.5 - 98.5 x 75.6 Seat Height (cm) 41 - 51 Good Quality Brands

ANTHROPOLOGY

LIST OF EQUIPMENTS

ANTHROPOLOGY DEPARTMENT

<i>Sl.No</i>	<i>Item</i>	<i>Description</i>
1	Martin's Spreading Calliper (Sharp end)	Spreading calliper made of brass chrome plated range 0-300mm pointed end
2	Static Goniometer	Attachable mollison type 0-180 Deg.
3	Cubic Craniophore	Cubic craniophor made of steel with skull holder precise, 28-cm square
4	Tubular Craniophore	Martin type, with skull holder.
5	Horizontal Needle (of Martin's)	Horizontal needle, size 450mm in height.
6	Skinfold Calliper (Harpenden)	Harpenden skinfold calliper to assess degree fatness, girth measurement of small joint. UK made CE mark measuring range 0 - 80 mm resolution of measurement 0-2mm, contacttip made of SS.
7	Glass slide	75mm X 75mm, PK of 100
8	Glass stirrer	150mmx 6 mm, pk 20
9	Lancet	Stainless steel blood lancet pk100
10	Human Skull	human skull, Size19x15x21 cm Made of fiber glass



LIST OF GLASSWARE/PLASTICWARE

ANTHROPOLOGY DEPARTMENT

1.	GLOVES (LARGE, LATEX, DISPOSABLE, PACK OF 100)	GLOVES (LARGE, LATEX, DISPOSABLE, PACK OF 100)
2.	REAGENT BOTTLE,wide mouth screwcap capacity:500ml	REAGENT BOTTLE,wide mouth screwcap capacity:500ml
3.	REAGENT BOTTLE,wide mouth screwcap capacity:250ml	REAGENT BOTTLE,wide mouth screwcap capacity:250ml
4.	REAGENT BOTTLE,wide mouth screwcap capacity:125ml	REAGENT BOTTLE,wide mouth screwcap capacity:125ml
5.	GLASS BAKER, Borosilicate Glass, Capacity:500ml	GLASS BAKER, Borosilicate Glass, Capacity:500ml
6.	GLASS BAKER, Borosilicate Glass, Capacity:250ml	GLASS BAKER, Borosilicate Glass, Capacity:250ml
7.	GLASS BAKER, Borosilicate Glass, Capacity:100ml	GLASS BAKER, Borosilicate Glass, Capacity:100ml
8.	CONICAL FLASK, Borosilicate Glass, Capacity:500ml	CONICAL FLASK, Borosilicate Glass, Capacity:500ml
9.	CONICAL FLASK, Borosilicate Glass, Capacity:250ml	CONICAL FLASK, Borosilicate Glass, Capacity:250ml

LIST OF INFRASTRUCTURE

ANTHROPOLOGY DEPARTMENT

Sl. No.	Product Name	Technical Specification	Preferred Brand
1.	Book Case	<p>Size of 1675 (h) x 8405 (w) x 310 (d) mm, shelves 4 no. Front open with transparent glass. High quality cold rolled close annealed (CRCA) sheet. Anticorrosion treated components, treated with seven step anti corrosion process as per IS: 3312:84. Thickness of door frame should be 18-20 gauge having transparent 5mm front glass and rest body 20-22 gauge. Oven baked powder coated. Color -grey.</p> 	Godrej/Methodex/Featurelite & Equipment
2.	Steel Almirah	<p>Size & Technical Specification: Size of 1980(h) x 915(W) x 485(d) mm, storage shelves 4 no. adjustable make five compartment. High quality cold rolled close annealed (CRCA) sheet. Anticorrosion treated components, treated with seven steps anti corrosion process as per IS: 3312: 84 standard. Thickness of sheet is 20 gauge front. Three way bolting device and six lever lock (Dual Lock) with high quality hinges an overlapping doors. Oven baked powder coated. Color -grey.</p> 	Godrej/Methodex/Featurelite & Equipment
3.	S-Type Chair	<p><u>S Type</u> Chair Size: (Height 830 (450) X Width 530 X Depth 565) MM</p> <p>S Type single frame with full arm made out of 14 gauge tubular pipe with addition reinforcement at the corner fitted with 8 mm hot pressed ply on seat &back in fabric with high density foam with black leatherette finishing.</p> 	Godrej/Methodex/Featurelite & Equipment

GEOGRAPHY



LIST OF EQUIPMENTS

GEOGRAPHY DEPARTMENT

Sl.No.	Name of the Items	Make
1.	Planimeter	Golden Engineering
2.	Weather Map	Polyart set of 12
3.	Practical Box 1. Protractor 2. Set Square 3. Divider 4. Compass with pencil lid 5. Diagonal Scale 6. Normal Scale	Good Quality
4.	Rotameter (Digital /Flow measurement)	Good Quality
5.	Toposheets (Plateau, Plan mountains, River, V-Shaped and U-Shaped valley)	Survey of India
5(a)	Escarpments etc.	For lamination
6.	Thermometer	JRM
7.	Prismatic (compass with Tripod stand)	Golden Eng.
8.	Tape 30 meter	Freeman
8(a)	Measurement 50 meter	Freeman

LIST OF INFRASTRUCTURE:

GEOGRAPHY DEPARTMENT

Sl.No.	Name of the Items	Make
1.	Tracing Table (Important)	Best Quality
2.	White Board (3x6 ft.)	Alkosign
3.	<p><u>Steel Almirah</u> Size & Technical Specification: Size of 1980(h) x 915(W) x 485(d) mm, storage shelves 4 no. adjustable make five compartment. High quality cold rolled close annealed (CRCA) sheet. Anticorrosion treated components, treated with seven steps anti corrosion process as per IS: 3312: 84 standard. Thickness of sheet is 20 gauge front. Three way bolting device and six lever lock (Dual Lock) with high quality hinges an overlapping doors. Oven baked powder coated. Color -grey.</p> 	Godrej/Methodex/Featurelite & Equipment
4.	<p><u>S Type Chair</u> Size: (Height 830 (450) X Width 530 X Depth 565) MM S Type single frame with full arm made out of 14 gauge tubular pipe with addition reinforcement at the corner fitted with 8 mm hot pressed ply on seat &back in fabric with high density foam with black leatherette finishing.</p> 	Godrej/Methodex/Featurelite & Equipment
5.	<p><u>Book case</u> - Size of 1675 (h) x 8405 (w) x 310 (d) mm, shelves 4 no. Front open with transparent glass. High quality cold rolled close annealed (CRCA) sheet. Anticorrosion treated components, treated with seven step anti corrosion process as per IS: 3312:84. Thickness of door frame should be 18-20 gauge having transparent 5mm front glass and rest body 20-22 gauge. Oven baked powder coated. Color -grey</p> 	Godrej/Methodex/Featurelite & Equipment

BOTANY

LIST OF EQUIPMENTS

BOTANY DEPARTMENT

TRINOCULAR RESEARCH MICROSCOPE WITH BRIGHT FIELD, DARK FIELD & PHASE CONTRAST INVESTIGATION WITH CAMERA ATTACHEMNT.

Infinity Optical System

Sidentopf-type Trinocular Tube with Solid, heavy cast-metal stand, rectangular shape for high expandability.

Coaxial coarse and fine focusing. Height adjustment of the coarse drive 22 mm (total).

Height adjustment of the fine drive 2 μm per scale division.

Binocular observation tube 360° rotatable, inclination 30°, tube factor 1x.

Inter pupillary distance 55 mm - 75 mm adjustable at each observation tube.

Quintuple nosepiece with ball track.

Mechanical stage 160 mm x 130 mm with ergonomically placed coaxial knobs.

Adjustment range 76 mm x 52 mm.

Specimen holder with spring lever.

Köhler Condenser height adjustment with gear drive for exact adjustment according to.

Sophisticated illumination tube with centerable field diaphragm.

TRINOCULAR TUBE: Inclined 30°, tube factor 1x

REVOLVING NOSE PIECE: Quadruple revolving nosepiece, ball beared for smooth turning and long Lifetime.

Binocular Photo tube 30° (TF 1x) 100/100 changeable.

Eyepieces Wide Field 10X - Pair

Objective lenses should be suitable for bright field & phase contrast observation:

Objective PLAN achromat or higher 10/0,25

Objective PLAN achromat or higher 20/0,35

Objective PLAN achromat or higher 40/0,65

Objective PLAN Oil Immersion, achromat or higher 100/1,25

Small combination condenser NA 1,25 with aperture diaphragm and filter holder can be switched from bright field to phase contrast Diaphragm for dark field for objective A Ph 40:1

Illumination : High intensity halogen/LED, Suitable for Bright field/Dark field & phase contrast observations with all the required filters & other necessities for the above applications

Image documentation : High sensitivity/high resolution dedicated digital camera (minimum 5 or more Mega Pixel with 30 FPS or more) with firewire connectivity

Image analysis : Software for analyzing (image capture & Measurement, image stitching, object counting, time laps etc) and documenting the captured images

Microscope, Digital Camera and image analysis Software should be from same manufacture for better synchronization & compatibility.

To quote separately for a **Suitable desktop computer** with UPS and 20" LED Monitor for analyzing /archiving the images.

Set of accessories: minimum 2 eye guards, filter slide II blue and Green, immersion oil-2 Nos (15 ml, n = 1,515), spare bulb halogen (2 Nos), Mains cable, 2 spare fuses, 2 centering keys, Dust cover .

Warranty: Minimum 1 year warranty

- The firm submitting the tender documents should have the credentials to supply scientific equipment, particularly microscopes in at least five numbers in the state of Odisha.
- The firms should have an annual turnover of 1 crore last year. This should be certified by a qualified firm or Chartered Account.
- The firm should not have been blacklisted from any of the Govt. agencies. An undertaking should be submitted in this regard.
- Satisfactory performance of the equipment should be submitted at least from three users in the state of Odisha.
- There should be at least 10 installations of the microscope in the state of Odisha.
- There should be an authorized service center in the state of Odisha



STATISTICS

LIST OF EQUIPMENTS
STATISTICS DEPARTMENT

Sl.No.	Name of the Items	Specification/ Brand Name
1.	Scientific Calculator	CLASSIC/ OREVA/ ORPAT

LIST OF INFRASTRUCTURE

STATISTICS DEPARTMENT

<p>1.</p>	<p><u>Steel Almira</u> Size & Technical Specification: Size of 1980(h) x 915(W) x 485(d) mm, storage shelves 4 no. adjustable make five compartment. High quality cold rolled close annealed (CRCA) sheet. Anticorrosion treated components, treated with seven steps anti corrosion process as per IS: 3312: 84 standard. Thickness of sheet is 20 gauge front. Three way bolting device and six lever lock (Dual Lock) with high quality hinges an overlapping doors. Oven baked powder coated. Color -grey.</p> 	<p>Godrej/Methodex/Featurelite & Equipment</p>
<p>2.</p>	<p><u>Book Case</u> Size of 1675 (h) x 8405 (w) x 310 (d) mm, shelves 4 no. Front open with transparent glass. High quality cold rolled close annealed (CRCA) sheet. Anticorrosion treated components, treated with seven step anti corrosion process as per IS: 3312:84. Thickness of door frame should be 18-20 gauge having transparent 5mm front glass and rest body 20-22 gauge. Oven baked powder coated</p> 	<p>Godrej/Methodex/Featurelite & Equipment</p>
<p>3.</p>	<p>S Type Chair Size: (Height 830 (450) X Width 530 X Depth 565) MM S Type single frame with full arm made out of 14 gauge tubular pipe with addition reinforcement at the corner fitted with 8 mm hot pressed ply on seat & back in fabric with high density foam with black leatherette finishing.</p> 	<p>Godrej/Methodex/Featurelite & Equipment</p>

4.	<p><u>Steel Table</u> Size & Technical Specification Size of (Length 900 x Depth 600 x Height 755 mm). 19 mm thick teak beige wood color top. CRC square pipe frame with powder coated.</p> 	Godrej/Methodex/Featurelite & Equipment
----	---	--

PSYCHOLOGY



LIST OF EQUIPMENTS

PSYCHOLOGY DEPARTMENT

1. Memory Apparatus – 16
2. Psycho Physics
 Esthesiometer – 16 (callipers)
3. Table Screen
4. Weight lifting box – 16
5. Metronum (stop watch) – 16
6. Raven's Sandford Performance Progressive Metrics (RCPM)
 Test Booklet – 04
7. Thermotic Apperception Test (TAT) Booklet – 04
8. Jung's Word Association (WAT) Booklet – 04
 (with practical book – N. Mohanty & Girishbala Mohanty)

LIST OF INFRASTRUCTURE

PSYCHOLOGY DEPARTMENT

<p>1.</p>	<p><u>Steel Almirah</u> Size & Technical Specification: Size of 1980(h) x 915(W) x 485(d) mm, storage shelves 4 no. adjustable make five compartment. High quality cold rolled close annealed (CRCA) sheet. Anticorrosion treated components, treated with seven steps anti corrosion process as per IS: 3312: 84 standard. Thickness of sheet is 20 gauge front. Three way bolting device and six lever lock (Dual Lock) with high quality hinges an overlapping doors. Oven baked powder coated. Color -grey.</p> 	<p>Godrej/Methodex/Featurelite & Equipment</p>
<p>2.</p>	<p><u>Book Case</u> Size of 1675 (h) x 8405 (w) x 310 (d) mm, shelves 4 no. Front open with transparent glass. High quality cold rolled close annealed (CRCA) sheet. Anticorrosion treated components, treated with seven step anti corrosion process as per IS: 3312:84. Thickness of door frame should be 18-20 gauge having transparent 5mm front glass and rest body 20-22 gauge. Oven baked powder coated. Color - grey.</p> 	<p>Godrej/Methodex/Featurelite & Equipment</p>
<p>3.</p>	<p>S Type Chair Size: (Height 830 (450) X Width 530 X Depth 565) MM S Type single frame with full arm made out of 14 gauge tubular pipe with addition reinforcement at the corner fitted with 8 mm hot pressed ply on seat &back in fabric with high density foam with black leatherette finishing.</p> 	<p>Godrej/Methodex/Featurelite & Equipment</p>

GEOLOGY

LIST OF EQUIPMENTS

GEOLOGY DEPARTMENT

EQUIPMENT		
Sl. No	Name of the instruments	Approx. price (in Rs.)
1.	Brunton Compass (3nos.)	

GLASSWARE		
Sl. No	Name of specimens	Approx. price (in Rs.)
1.	A. Aerial Photography (6 nos.) B. Satellite Images (6 nos.) Total pair –12 no.	Pair

TERMS & CONDITIONS

(I) ELIGIBILITY CRITERIA:

The tenderers must fulfill the following eligibility criteria failing which their offer will be summarily rejected:-

1. The tenderer must possess required valid licenses, Registration etc. issued by the Competent Authority as per law.
2. The tenderer must deposit earnest money of **2% of quoted value (refundable)** along with their 'tender payable in the form of Account payee Demand Draft favouring **Principal, Rajdhani College, Bhubaneswar** payable at **Bhubaneswar**.
3. The tenderer must deposit the cost of tender document of **Rs.500/-** (Rupees Five Hundred only) in the form of account payee demand draft in favour of **Principal, Rajdhani College, Bhubaneswar** payable at **Bhubaneswar** only (non-refundable).
4. The tenderer must have its own bank Account, PAN and GST Number.

II.DOCUMENTS TO BE ENCLOSED

The tenderer must submit the following documents along with the tender failing which their offer will be summarily rejected:-

1. Self attested photocopy of documentary proof of the registration/license etc. issued by the Competent Authority.
2. Self attested photocopy of income tax return and/or audited balance sheet of the last 03 Financial Years 2020-21 to 2022-23.
3. Self attested photocopy of bank account (front page)/bank statement, PAN, Goods and Service Tax Registration Certificate.
3. Original demand draft of 2% of quoted value (refundable) pertaining to earnest money in the form of account payee demand draft in favour of **Principal Rajdhani College, Bhubaneswar** payable at **Bhubaneswar** only.
4. Original demand draft of **Rs.500/-** (Rupees five hundred only) (non-refundable) being the cost of tender document in the form of account payee demand draft in favour of **Principal Rajdhani College, Bhubaneswar** payable at **Bhubaneswar** only.
5. Self attested photocopy of certificate of dealership/distributorship/authorization letter as applicable.

(III) OTHER TERMS & CONDITIONS:

1.0. Submission of Bids:

- 1.1. The tenderer shall submit their bid on the letterhead of the tenderer addressed to the **Principal Rajdhani College, Bhubaneswar** containing the information detailed at Annexure-01 and Annexure – 02.

1.2 Mode of Submission

(i) Bid must be placed in a sealed envelope clearly super-scribed as “**Quotation for Laboratory Equipments, Chemicals and Infrastructure**” (Name of the item) vide Tender Call Notice No. 616 dated 17.02.2023.

(ii) Tenders/bids submitted through Fax and Email will not be considered at all.

1.3 Bid Opening: The Bids shall be opened by the College in accordance with the exact procedure, tender terms and conditions.

2. Tender Documents Availability & Cost: The tenderer / bidder may download the tender document from the College Website (i.e. www.rajdhnicollege.org.in). The tenderer are required to enclose along with their Bid a demand draft of **Rs. 500/-** (Rupees Five Hundred only) as the cost of the tender document (non-refundable).

3. Validity of Bids: Tender/Bids must be valid for 120 days from the tender opening date.

4. Tendered Quantity and Variation: The approximate required quantity of items may vary (more or less) as per the requirement of the College.

5. Delivery Period: The successful tenderer must be able to supply, install and commission the goods within 60 days from the date of issue of Supply Order. Delayed supply will attract the levy of penalty/liquidated damages.

6. Penalty: If the suppliers fails to deliver by the specified date, penalty at the rate of 1% per week of the total order value subject to the maximum of 10% of total order value will be deducted.

7. Payment: "Advance Payment" is not allowed in any case. 100% payment will be released after completion of the supply, successful installation and commissioning of water coolers, subject to submitting Performance Security Deposit.

8. Tender Opening: Tender will be opened at **3.00 pm** on dt. **27.02.2023**. The bidders or their authorized representative may also witness the opening.

9. Settlement of Disputes:

In the event of any dispute or difference(s) between the Principal, Rajdhani College, Bhubaneswar and the vendor(s) arising out of non-supply of material or supplies not found according to the specifications or any other cause whatsoever relating to the supply or purchase order before or after the supply has been executed, shall be referred to the **Principal, Rajdhani College, Bhubaneswar** who may decide the matter himself or may appoint arbitrator(s) under the Arbitration and Conciliation Act 1996. The decision of the arbitrator shall be final and binding on both the parties.

All disputes shall be subject to Jurisdiction of courts at Bhubaneswar only.

10. Return of EMD to unsuccessful tenderers.

The unsuccessful tenderers shall be returned of their EMD demand draft within 15 days after finalization of the tender and issue of supply order in favour of successful tenderer. However, the EMD of the successful tenderer shall be retained by the College till the performance security deposit of the full amount is deposited by him in the form of bank guarantee/FDR.

11. Condition of goods.

The supplier must supply the goods in good condition without any defect whatsoever to the satisfaction of the College. Any deviation in the material and the specifications from the

accepted terms is liable to be rejected and the suppliers need to replace the rejected goods free of cost in the specified form to the satisfaction of the College.

12. Dispatch of tender bids by the tenderer.

(i) The tenderers may send their bids by speed post or registered post only addressed to the **Principal, Rajdhani College, Bhubaneswar, Odisha PIN 751003** so as to reach the College on or before **27.02.2023 (2.00 pm)**.

(ii) The bids sent through normal post or courier or Fax or e-mail shall not be considered.

13. Principal, Rajdhani College, Bhubaneswar reserves the rights to accept/reject any offer in full or in part without assigning any reason thereof.

Sd/-
Principal, Rajdhani College,
Bhubaneswar

N.B

**** Prices should include all applicable taxes and delivery, installation at desired location. (Taxes should be stated separately along with unit price).***

TECHNICAL BID

1. Name of the Tenderer :
2. Full Address of the tenderer :
3. Contact details of tenderer :
 - a) Telephone No.
 - b) Mobile :
 - c) Fax No. :
 - d) Email ID :
4. Details of Earnest Money Deposit (2% of quoted value refundable)
(DD must be placed in the Bid envelope)
 - a) D.D No.
 - b) D.D Date
 - c) DD amount
 - d) Issuing Bank
5. Details of cost of tender document deposited (Rs. 500/-non-refundable)
(DD must be placed in the Bid envelope)
 - a) D.D No.
 - b) D.D date
 - c) DD amount
 - d) Issuing Bank

6. List of Documents enclosed “

Sl.No.	Name of the Document	Information to be filled in this column		Whether photocopies of the documents enclosed (pl. tick)
i.	License /Registration (Number)			Yes / No
ii.	Dealership/Distributorship Certificate (Number)/Authorization letter			Yes / No
iii	Income Tax Return (Annual Income during last 03 Financial Years) Or Audited Balance Sheet & Profit and Lost Account Annual turnover during last 03 Financial Years	Rs. Rs. Rs.		Yes / No
iv.	Bank Account (Bank Name, Branch & Account Number)			Yes / No
v.	PAN (Number)			Yes / No
vi.	Good & Service Tax (Number)			Yes / No

7. Validity period of the Bid :

8. Additional information , if any proposed to be furnished by the tenderer.

Certificate : Certified that we accept all the terms and conditions of the tender documents.

Date :

Place:

Signature of authorized person

Full name :

Designation :

Seal:

FINANCIAL BID

1. Name of the item :
2. Quantity required :
3. Quantity proposed to be supplied :
4. Rates quoted by the tenderer in the following table:

Sl.No.	Detailed Specification of the Item	Total Unit Rate inclusive of basic cost, transportation, taxes, discount etc.	Total Amount (Qty, X Rate) (Rs.)

(Total amount in words Rupees)

5. Break up of total unit rate :

Sl.No.	Component	Amount	Remarks
a)	Basic cost		
b)	Transportation		
c)	GST		
d)	Discount if any		
e)	Any other		
	Total (Rs.)		

6. Validity period of Bid : _____
7. Delivery period : _____
8. Warranty period : _____
9. Installation period : _____

Certificate : - Certified that we accept all the terms & conditions of the Tender documents.

Date :

Place:

Signature of authorized person

Full name :

Designation :

Seal: